

лялька  
lalka

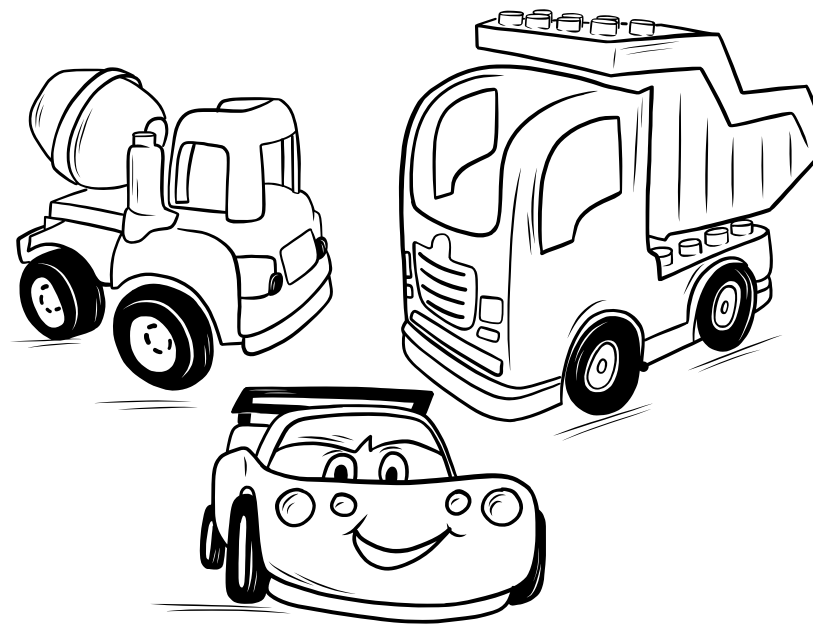

машина  
autko

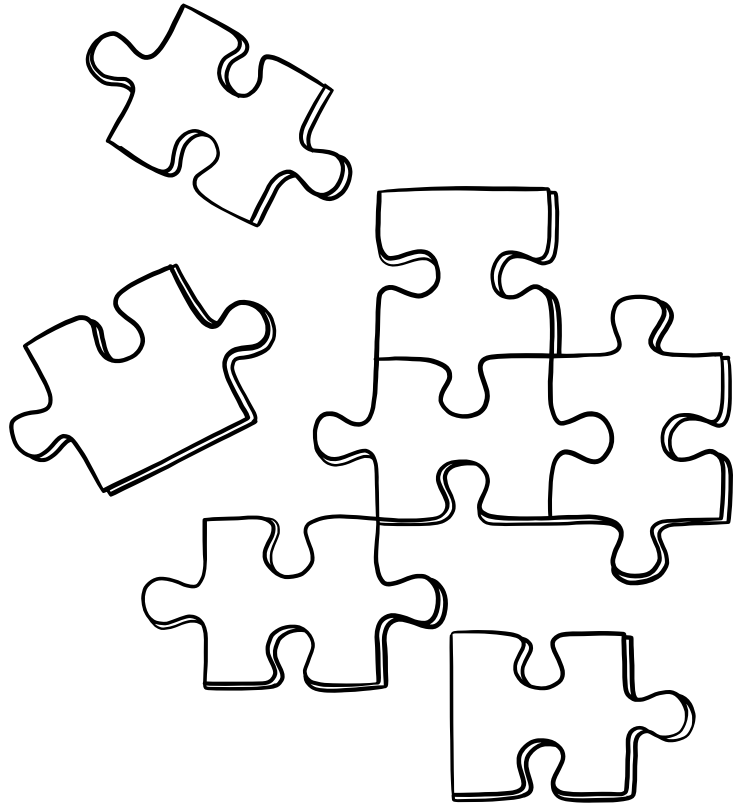

пазл  
puzzle

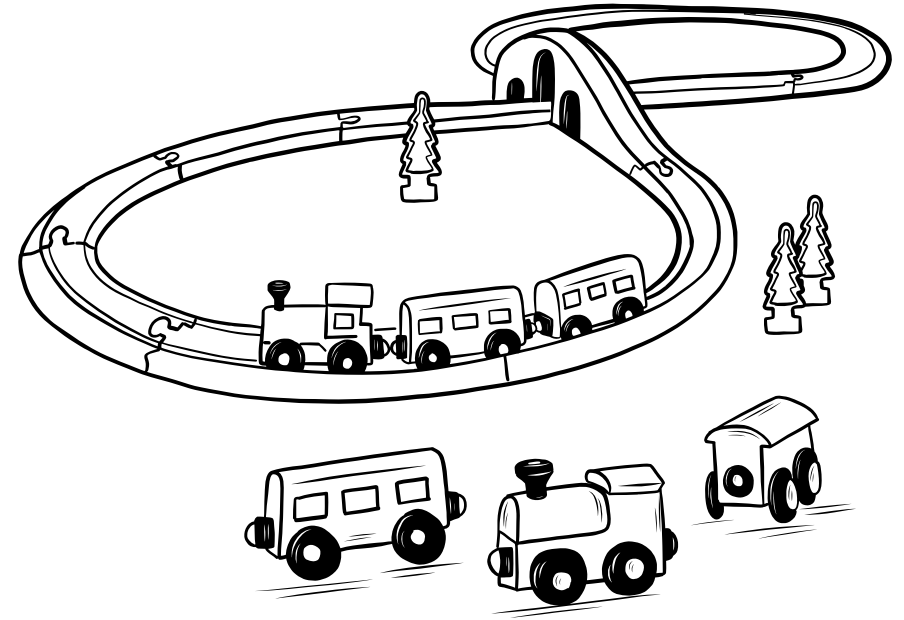

поїзд  
rosiad

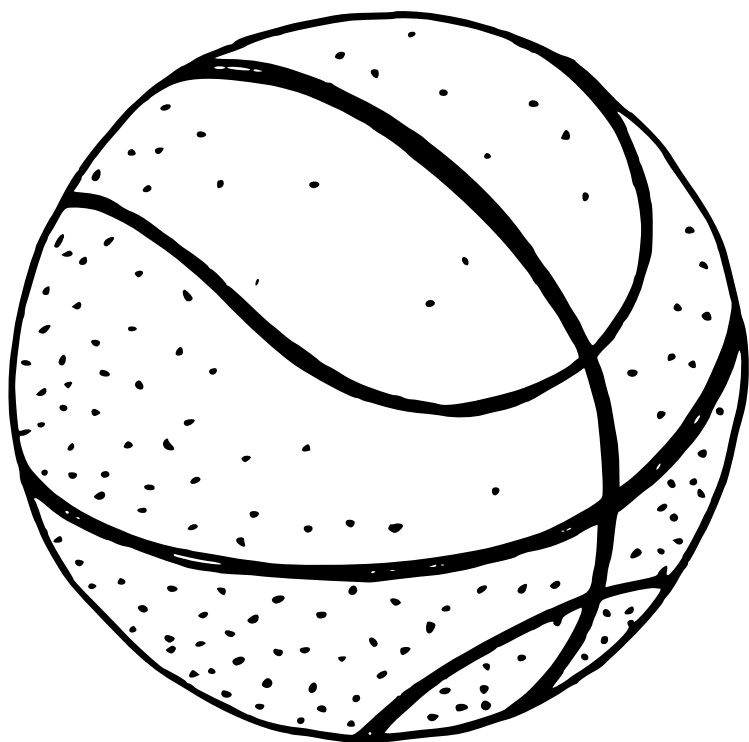

м'яч  
ріпка



розмальовки  
kolorowanki



напій  
рісіє

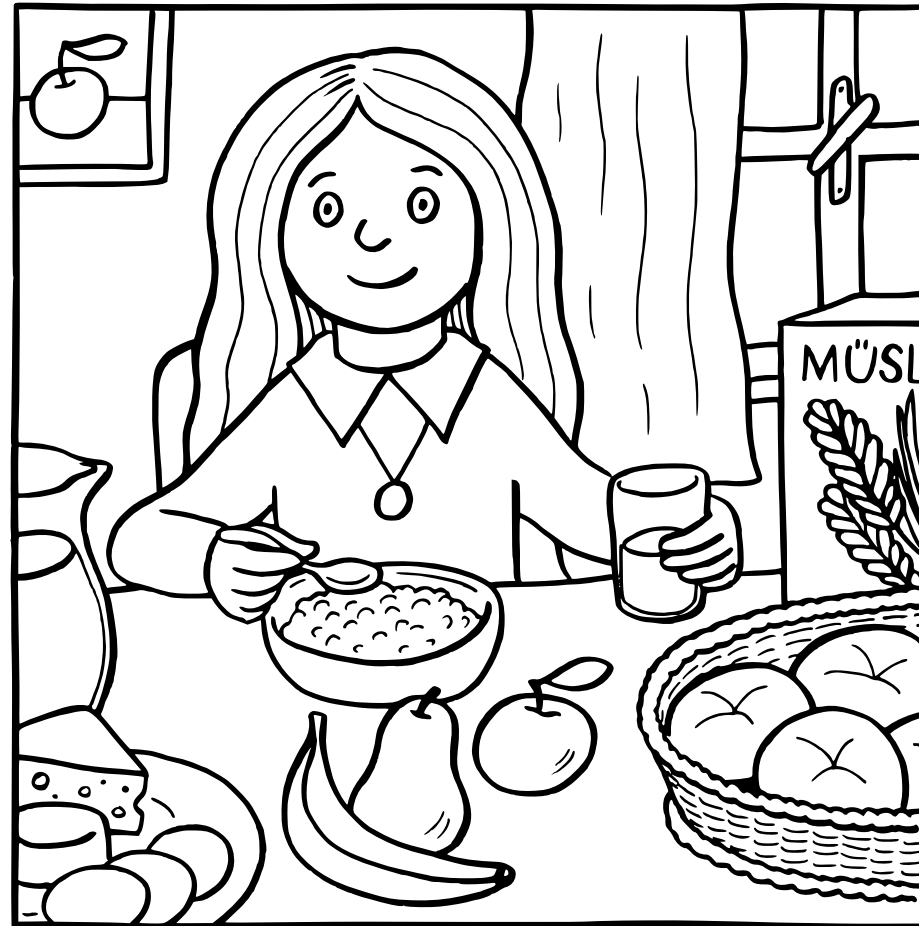

сніданок  
śniadanie



перекуска  
przekąska

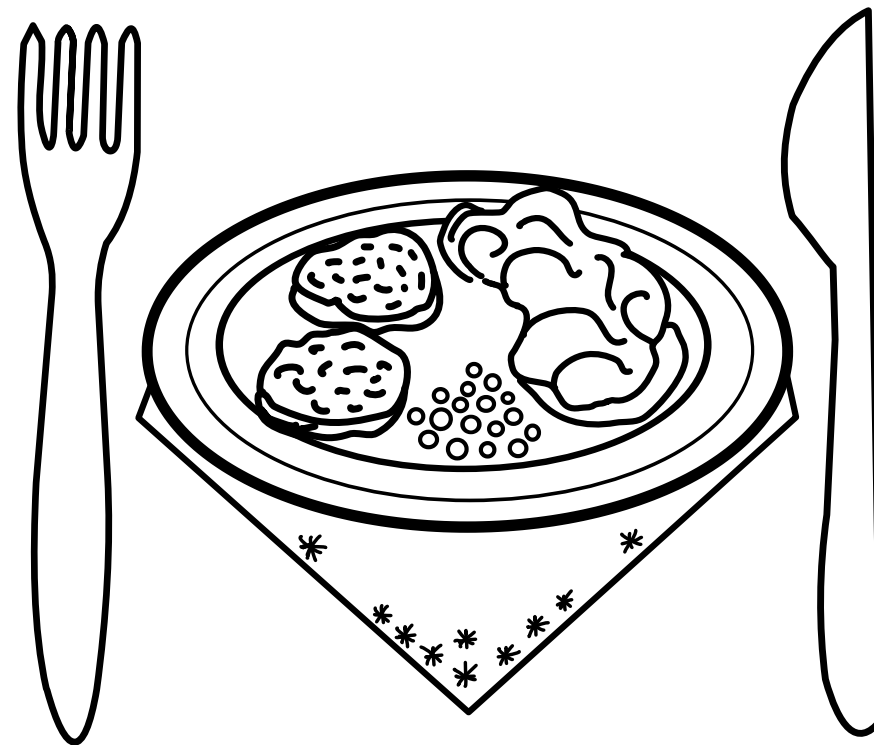

обід  
obiad

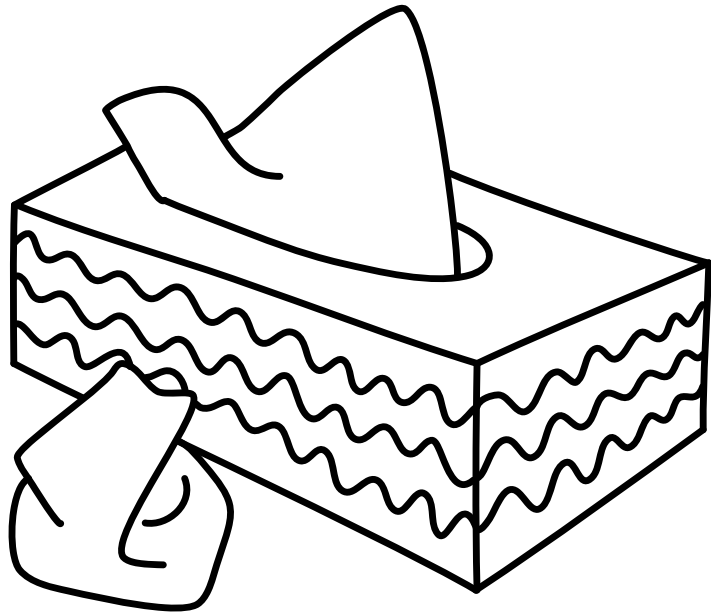

НОСОВА ХУСТИНКА  
chusteczka do nosa



ЛІЖКО  
łóżko



туалет  
toaleta



подорож  
wycieczka



сад  
ogród

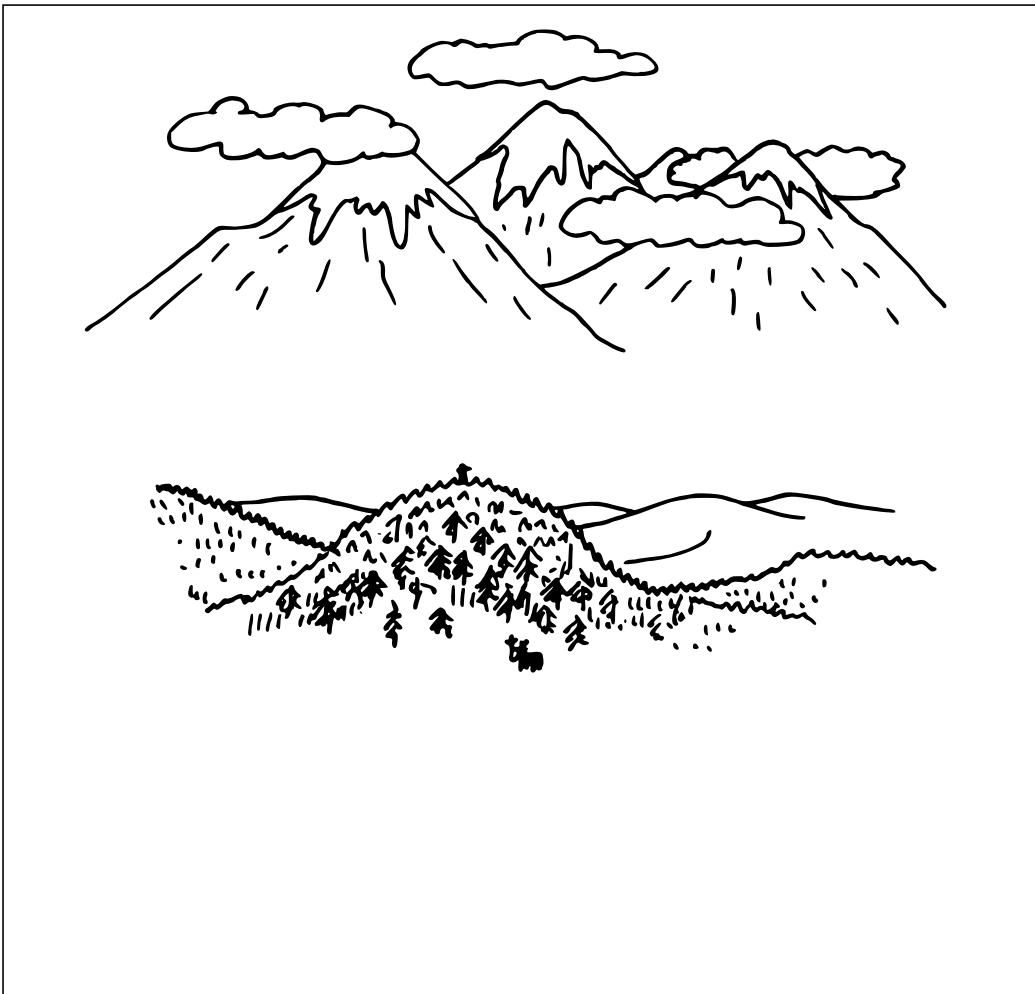

гори  
góry





кататися на  
ковзанах  
jeździć na łyżwach

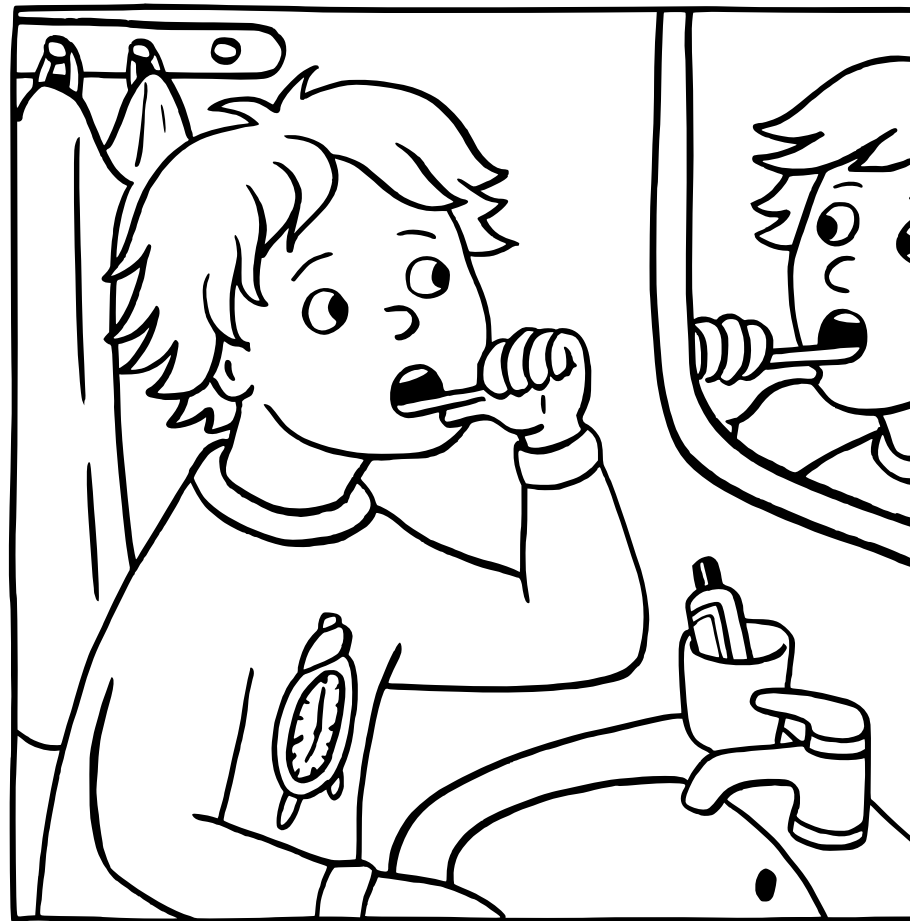

ЧИСТИТИ зуби  
myć zęby



робити вправи  
ćwiczyć



У мене болить  
живіт.  
Boli mnie brzuszek.

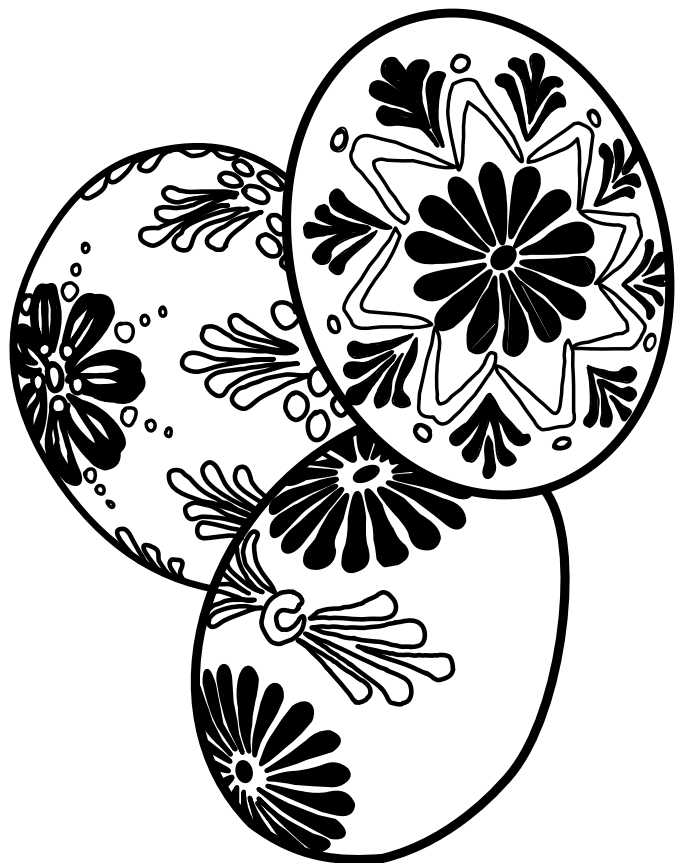

писанка  
pisanka



зайчик  
zajaczek

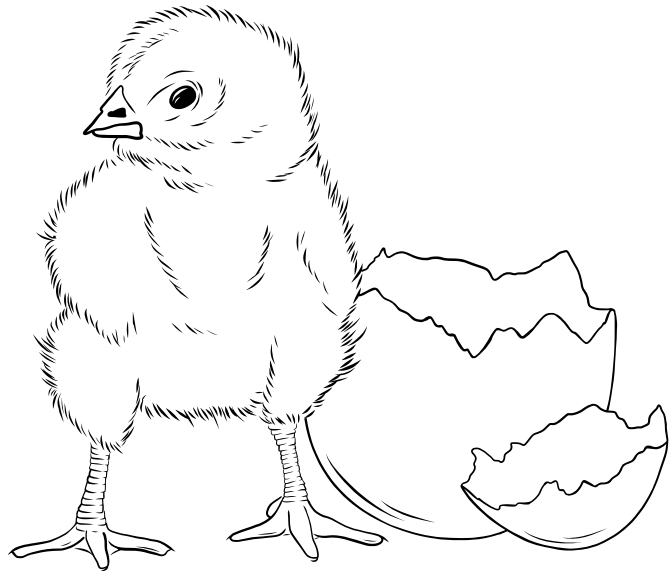

курчатко  
pisklę

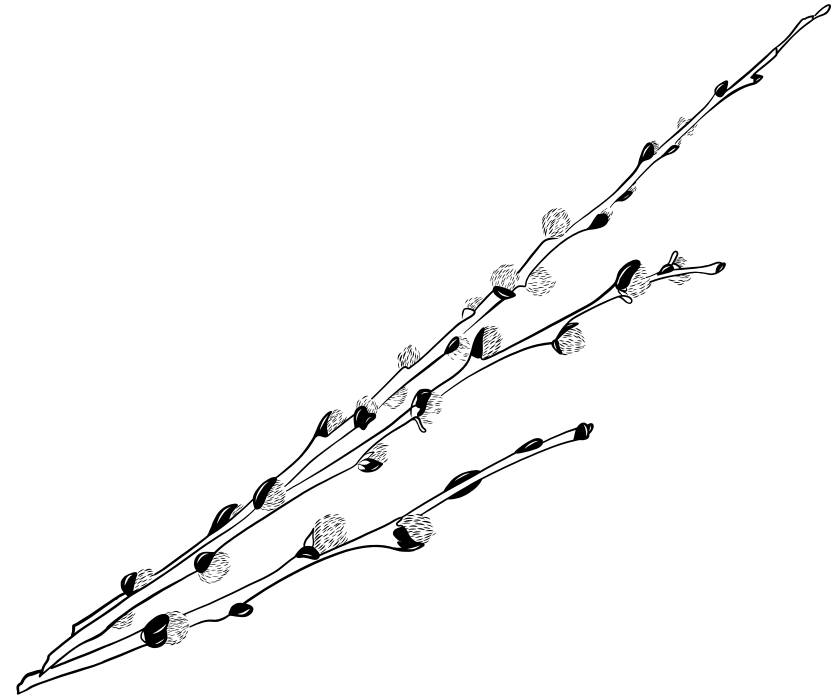

котики (цвіт верби)  
kotki (kwiaty  
wierzby)



баранець  
baranek



примула  
pierwiosnek



ТЮЛЬПАНИ  
tulipany

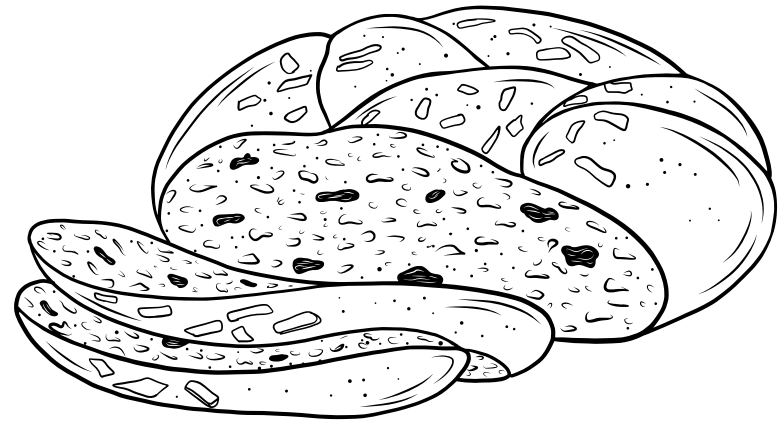

пасочка  
mazurek



мак  
mak



кульбаба  
dmuchawiec



бузок  
lilak



соняшник  
słonecznik



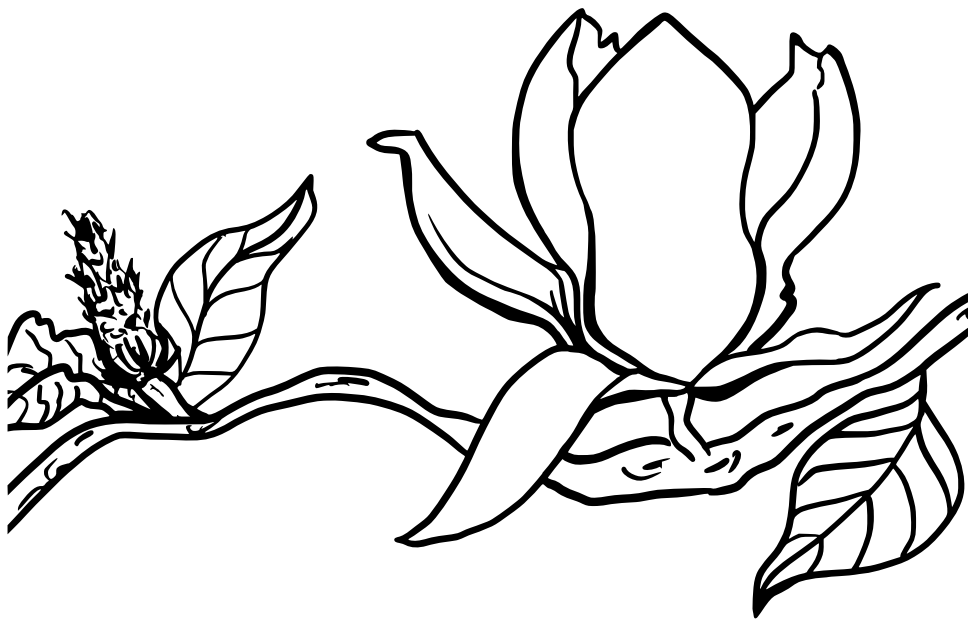

магнолія  
magnolia

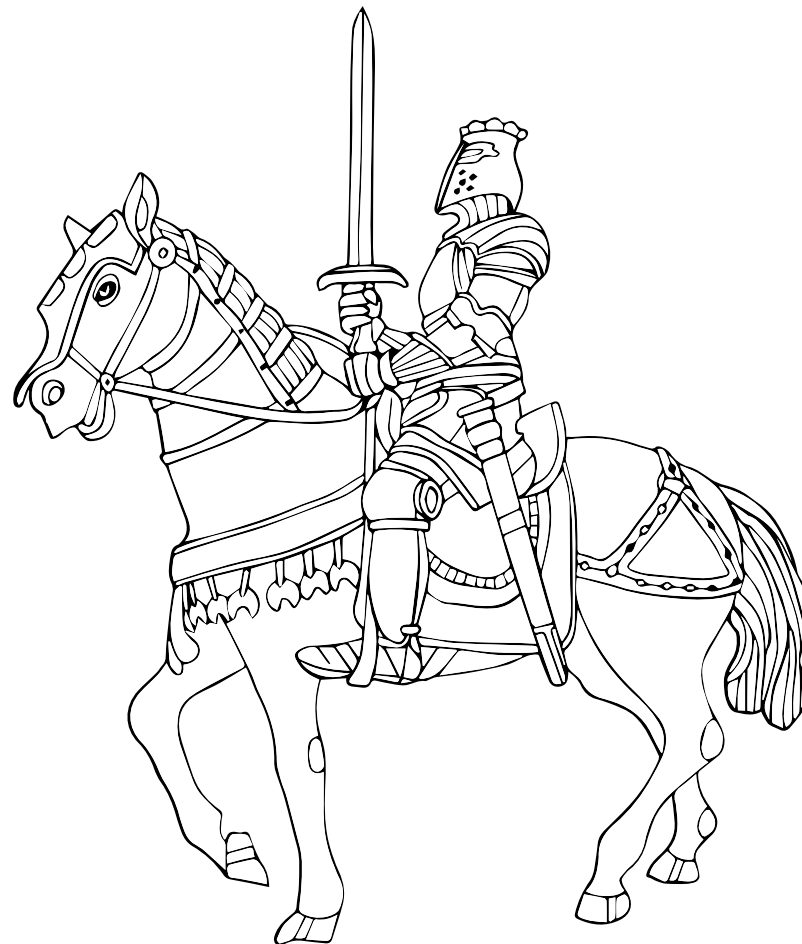

хоробрий лицар  
odważny rycerz



прекрасна  
принцеса  
piękna królewna



король  
król

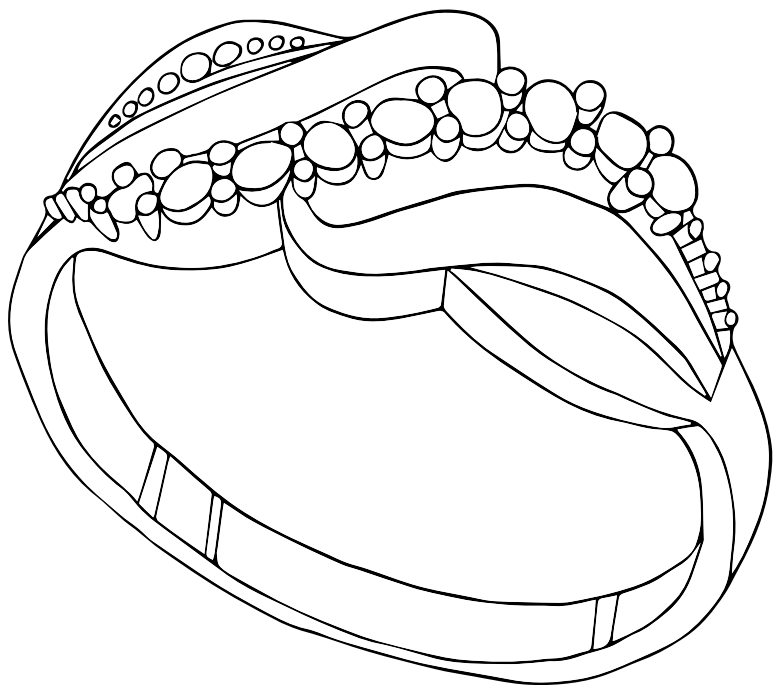

золотий перстень  
złoty pierścień

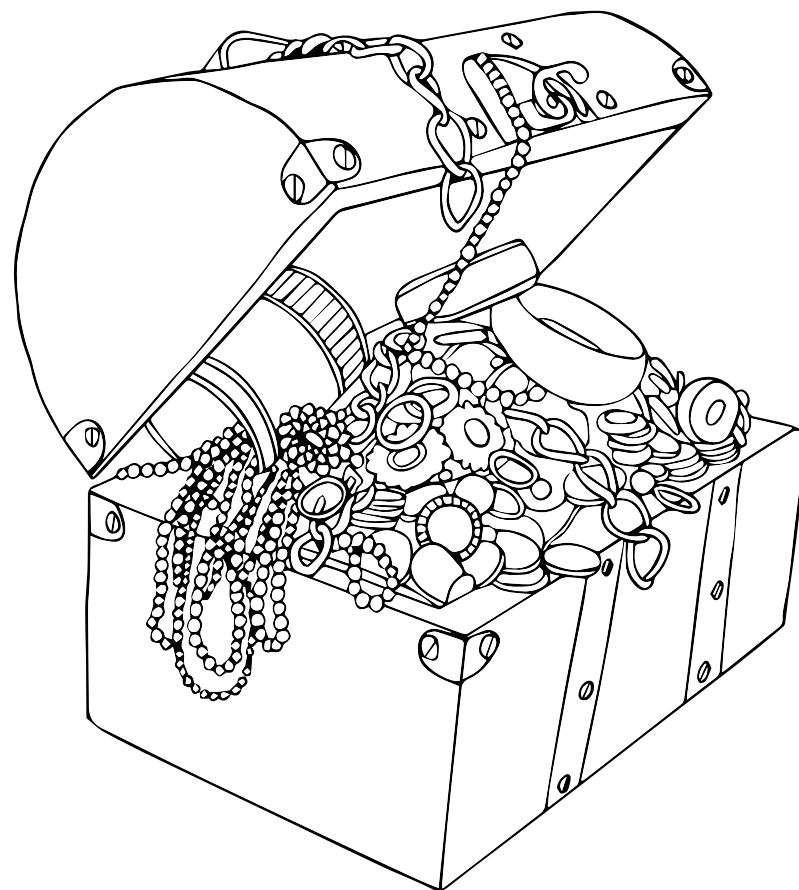

скарб  
skarb

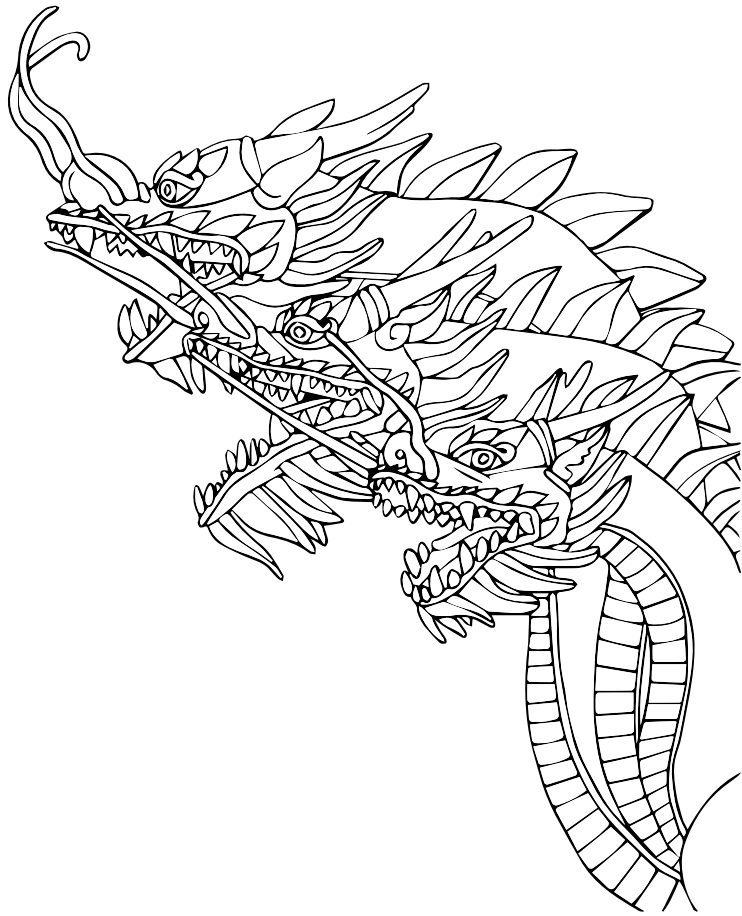

триголовий дракон  
trójgłowy smok



замок  
zamek

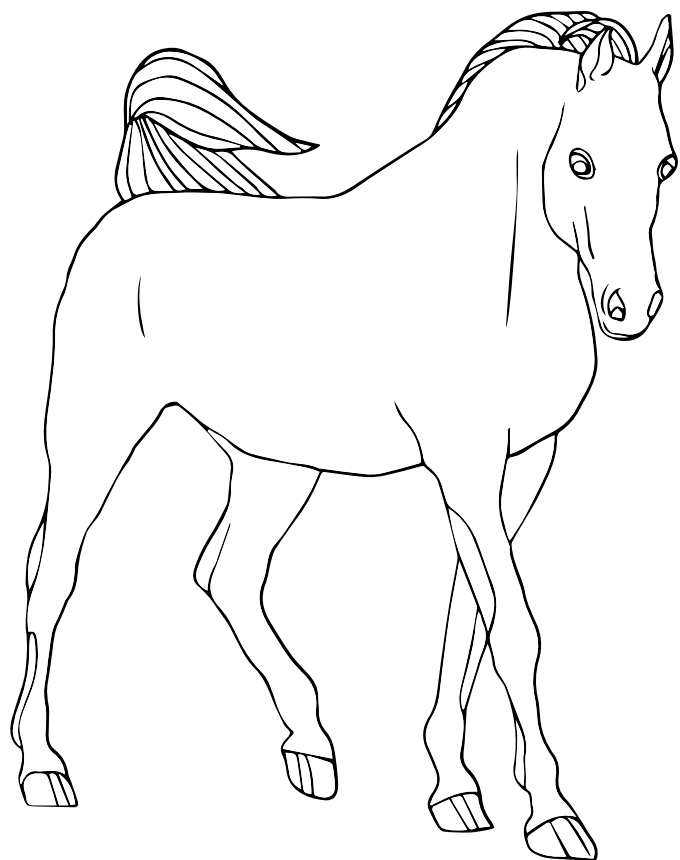

КІНЬ  
koń



ГЛІНТВЕЙН  
wino gotowane

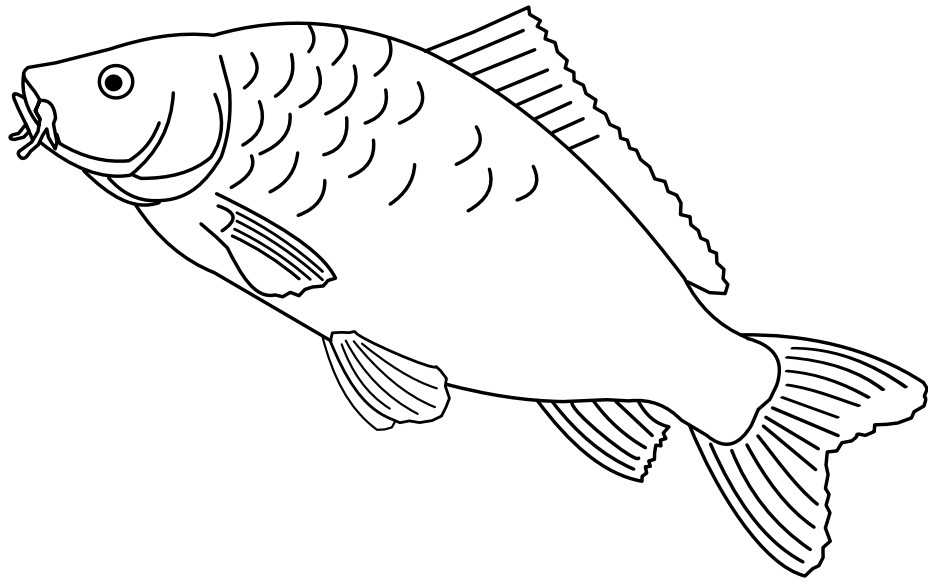

короп  
karp

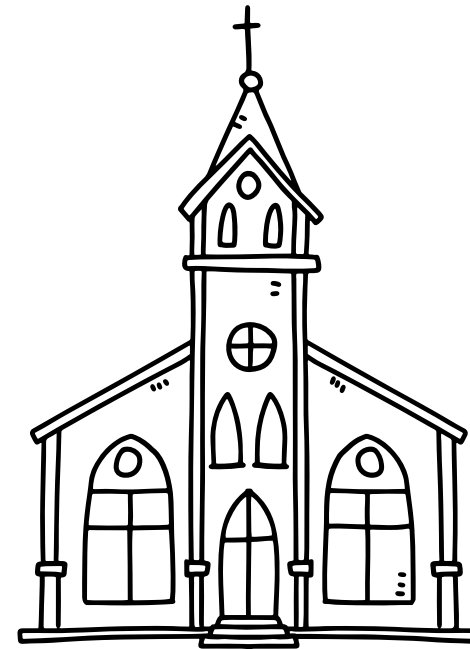

костел  
kościół

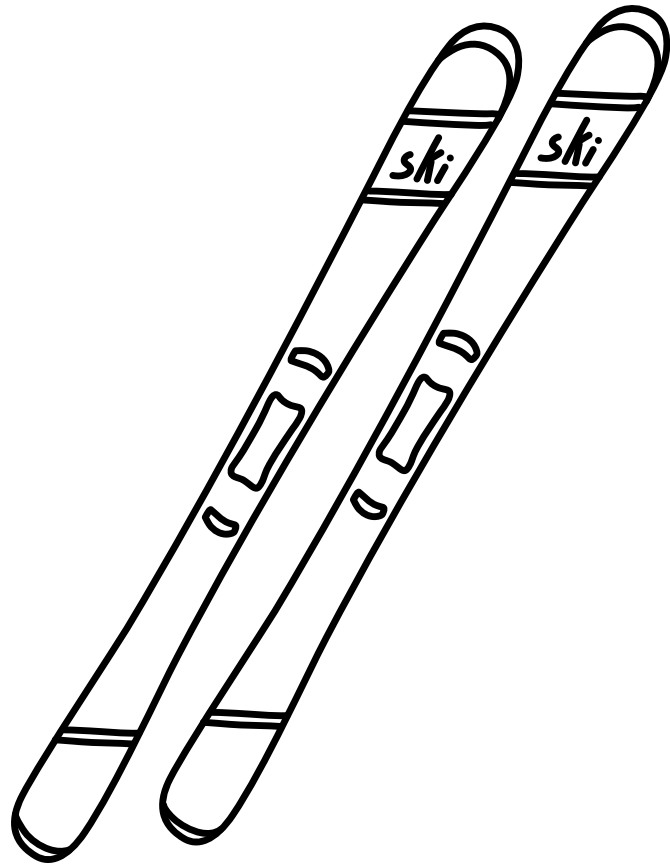

лижі  
narty

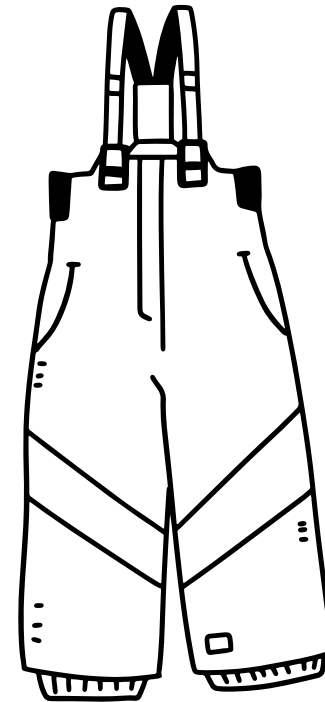

лижні штани  
spodnie narciarskie

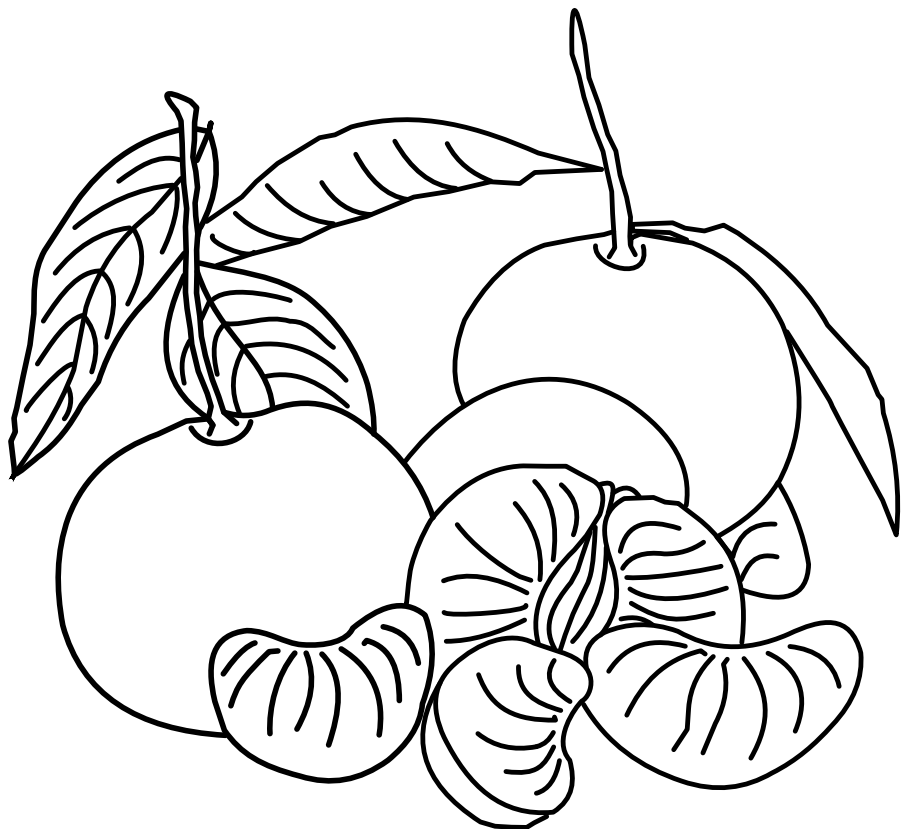

мандаринки  
mandarynki

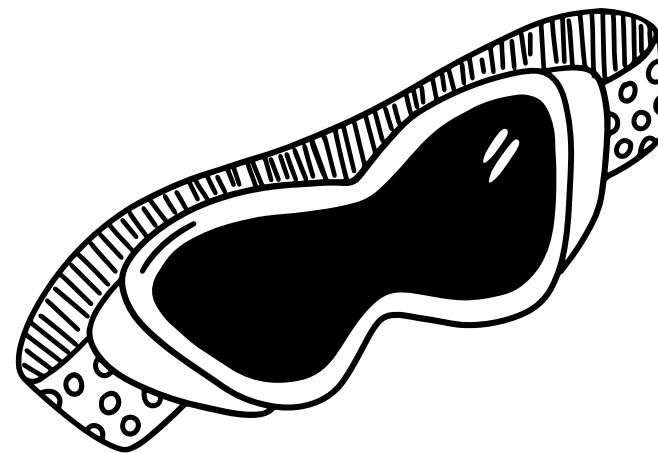

окуляри  
okulary





омела  
jemioła

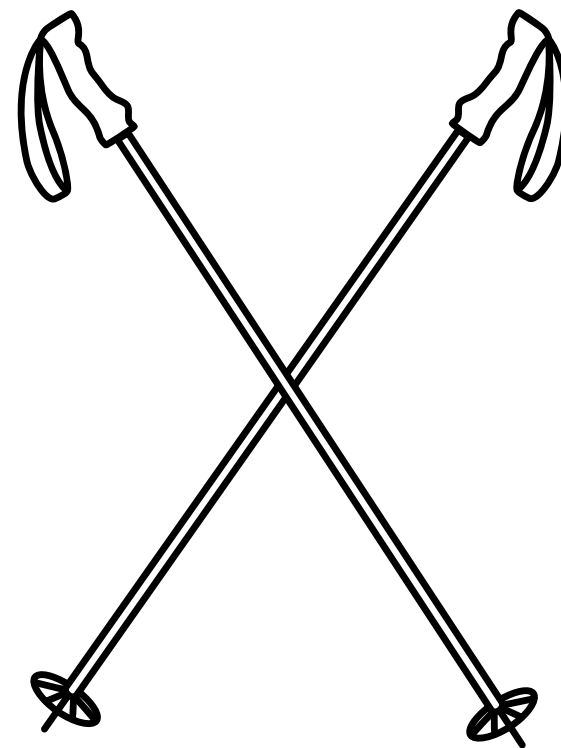

палки  
kijki

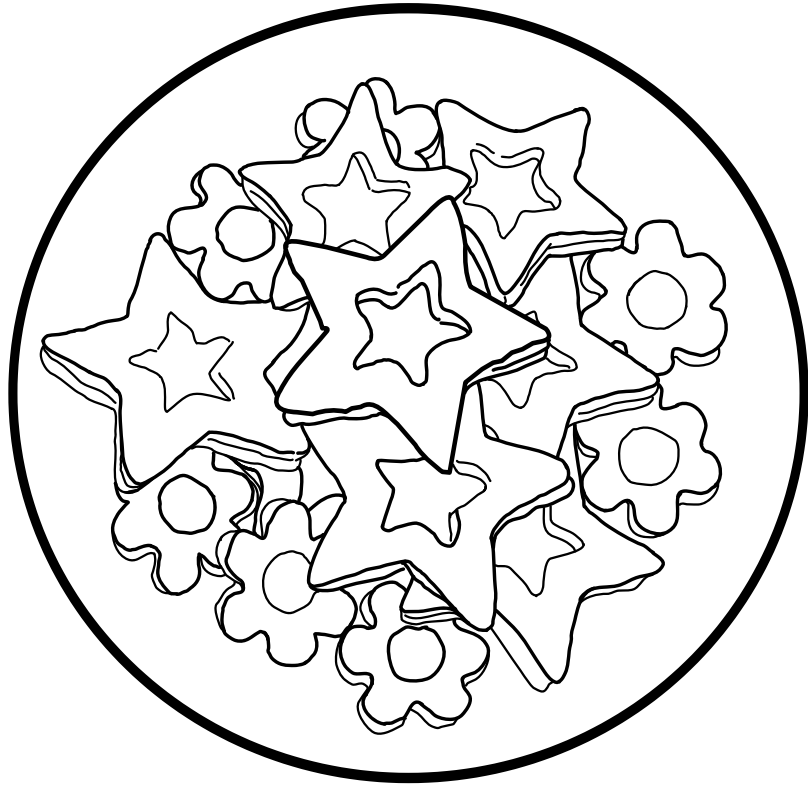

печиво з пісочного  
тіста  
kruche pieczywo

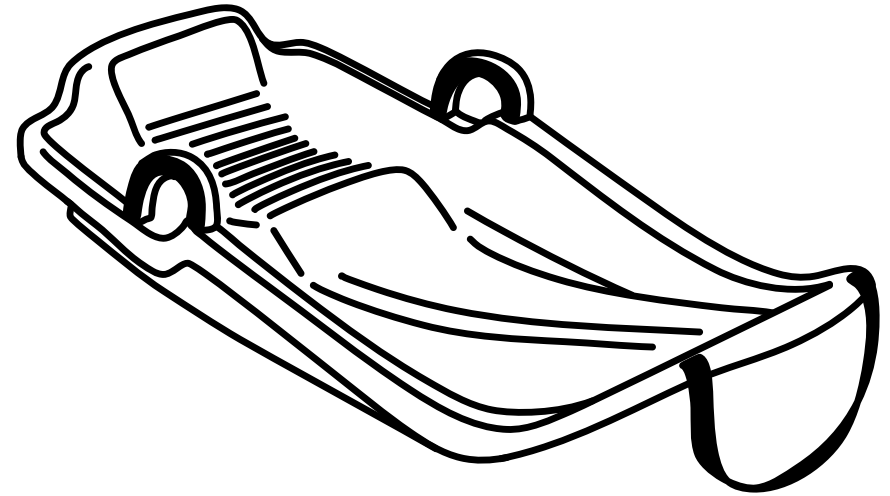

пластикові санчата  
plastikowe sanki



подарунок  
present



прянички  
pierniki

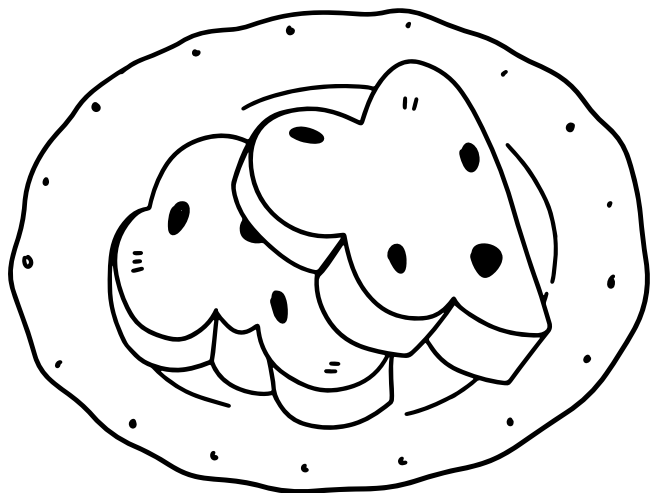

різдвяна булочка-  
плетінка  
chałka świąteczna

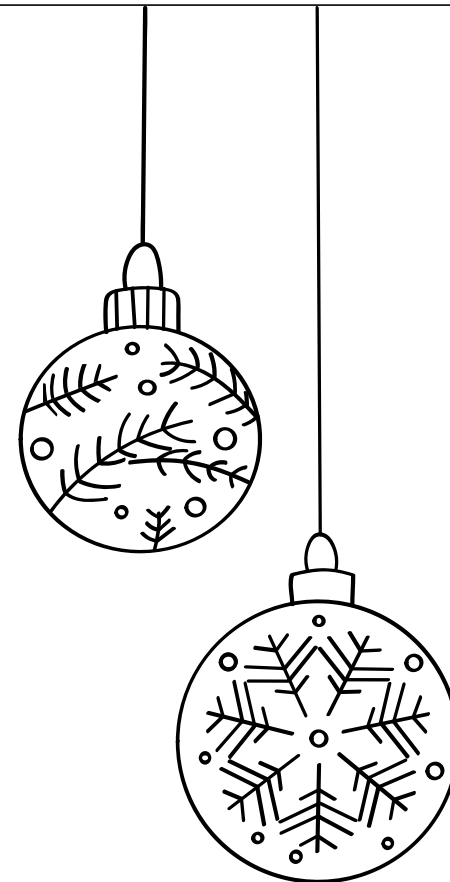

різдвяні прикраси  
ozdoby  
bożonarodzeniowe

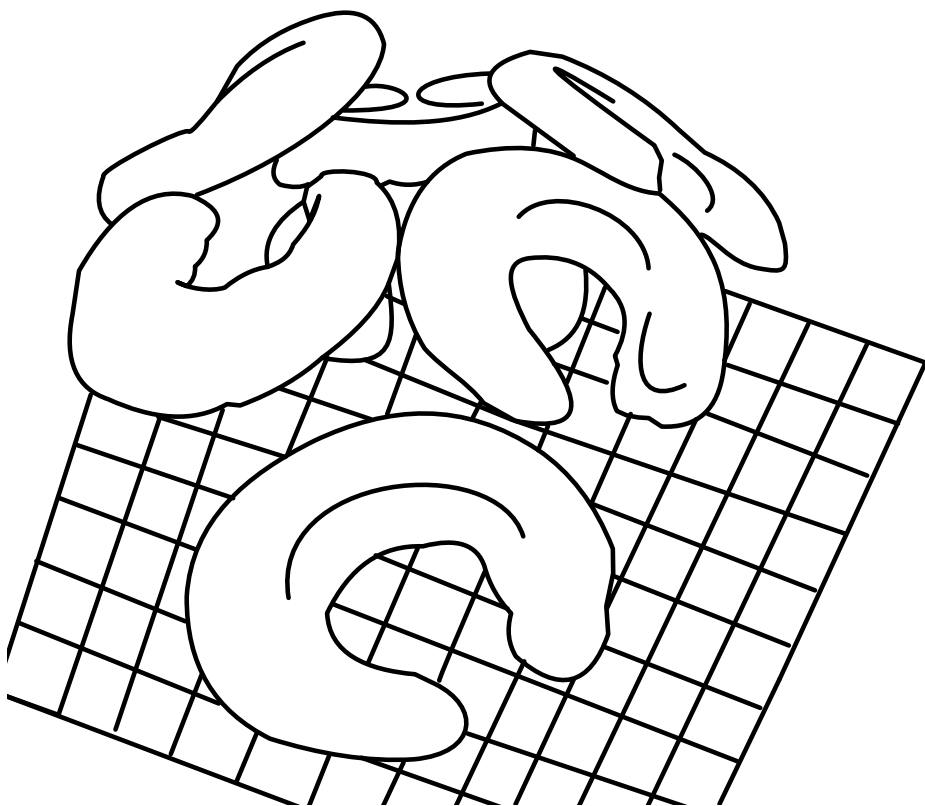

рогалики  
rogaliki

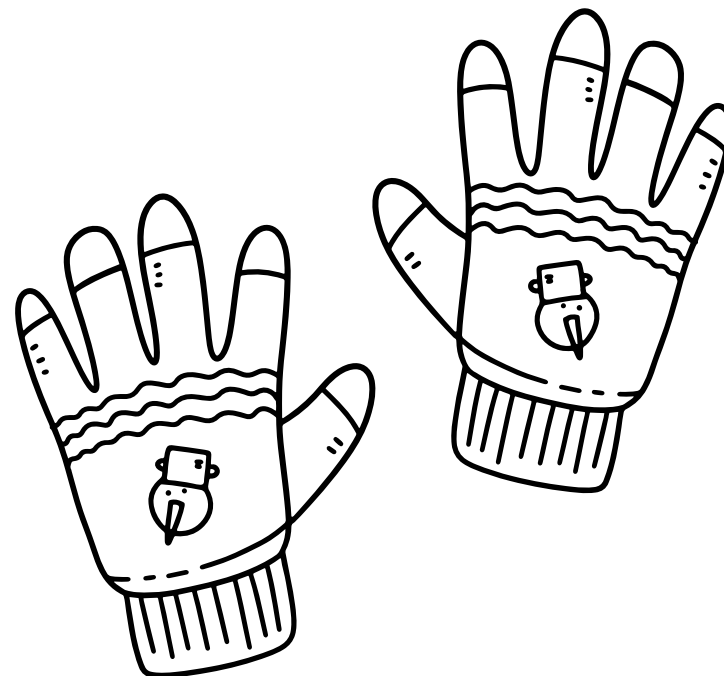

рукавиці  
rękawice

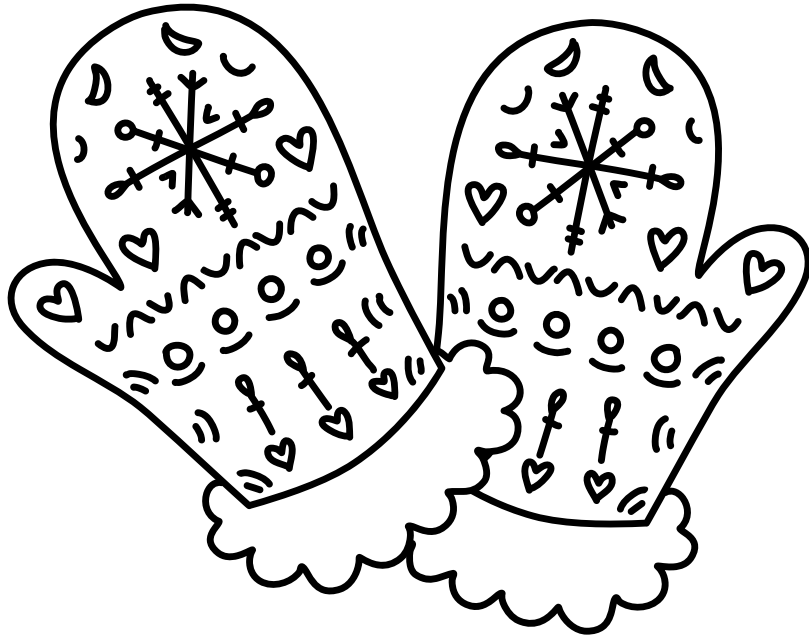

рукавиці (без  
пальців)  
rękawice bez palców

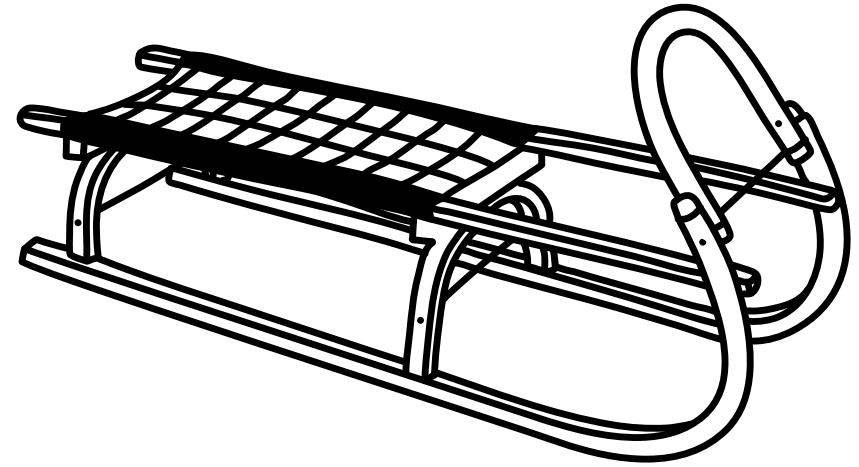

санчата  
sanki

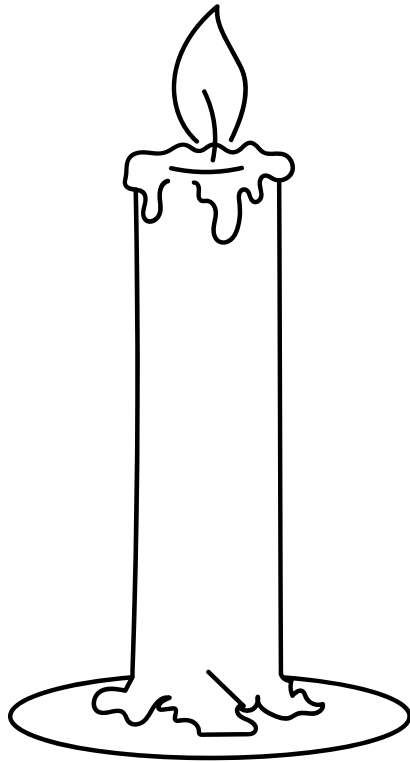

свічка  
świeczka

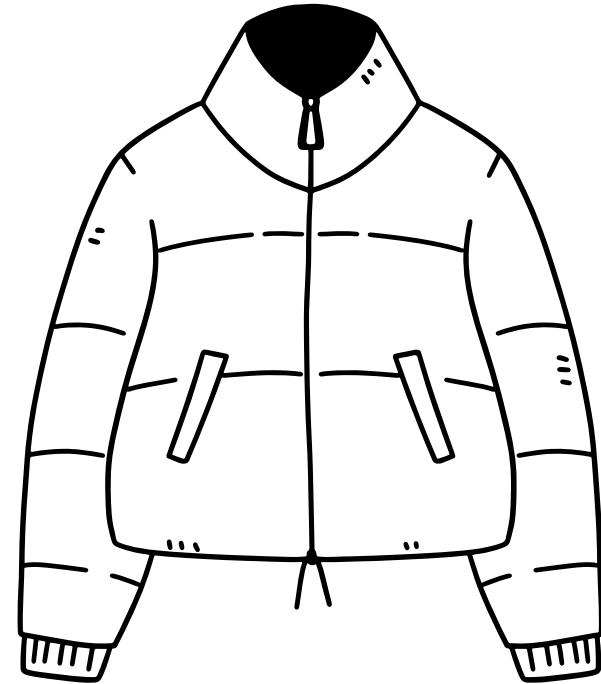

тепла куртка  
ciepła kurtka

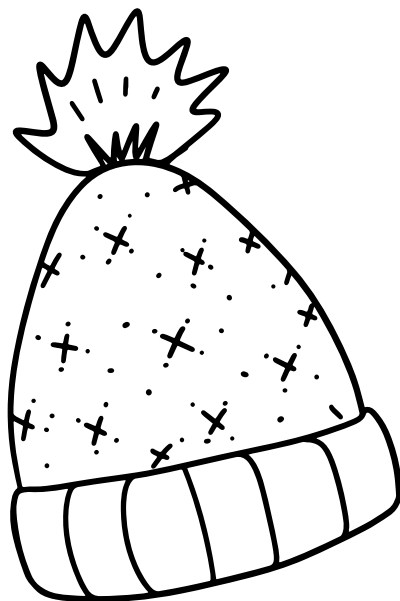

шапка  
czapka

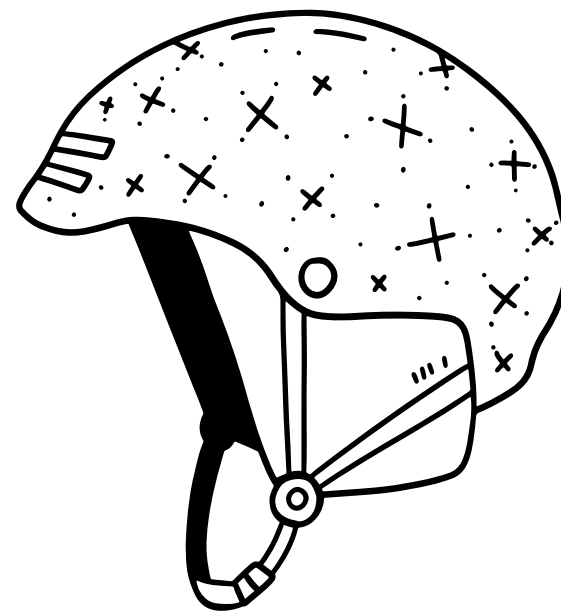

шолом  
kask



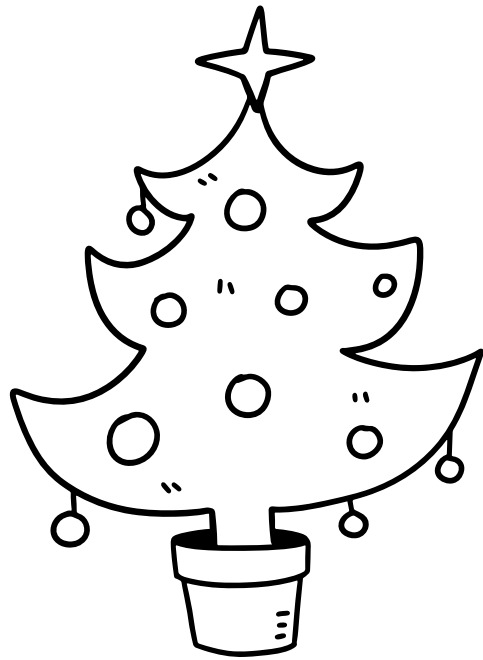

ялинка  
choinka  
bożonarodzeniowa



лижні черевики  
buty do nart